

57.70 N 11.96 E



Tech & Soul

Scandi-design **eyewear**. Driven
by environment & curiosity

tripoint

GLASSES WITH A MISSION

We want to make accessible innovative sports glasses that respect the environment and protect your eyes throughout every moment of your life.



Design

We love fashion, we love simple, we love innovative design.

We also love fair prices. So that cycling, skiing and traveling while being well protected remain moments that we can all enjoy.

Curiosity

In 50 years, we want to be able to look back on the sports glasses industry and laugh. Knowing things have changed, and we have played a major role in the transformation.

Environment

Whether it's about choosing our materials or selecting our partners, our glasses are manufactured according to a very strict set of specifications to ensure our products are safe and long-lasting.

Ever since we were kids, we have taken the environment for granted. But then we grew up and realized that nothing will last forever. That is why we have a sustainability mindset in everything we do.





WHAT DOES TRIPOINT STAND FOR?



The name Tripoint is a geographical point at which the boundaries of three countries or subnational entities meet. This creates a unique place and binds countries together.

Tripoints can be found all over the world. There are approximately 176 international tripoints. We are humble and respectful to these surroundings. Knowing they can hit us with full force. That is why we adapt, that is why we prepare, that is why Tripoint exists. Made to withstand the harsh and variable climate and ready to take on every challenge.

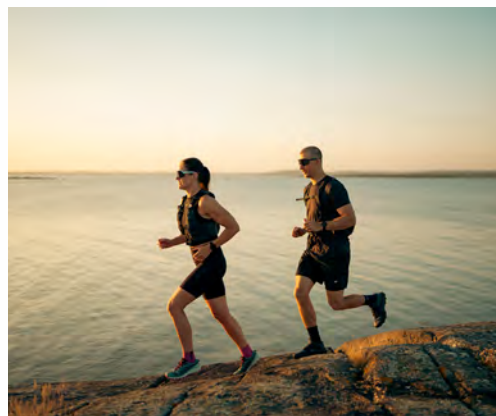



tripoint

TRI-X VISION
Lens boost technology

When the surroundings and the weather conditions are harsh and unpredictable. Or you want a lens that is perfectly adapted to your purpose. The Tri-X Vision lens technologies are here to help.

TRI-X | Nylon

The Tri-x nylon lens offer the pleasure of a crisp clear vision. The comfort of ultralight weight. Safety in form of durability and shatter resistance.

Nylon as material are Bio-based and free from harmful BPA chemicals.



TRI-X | UltraVue

The Tri-x contrast lens are made to boost colors and contrast in low light conditions. The lens blocks all the fuzzy colors in the color spectra. This results in a sharp, clear vision even in low light.

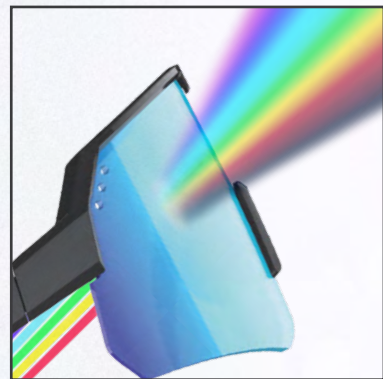

TRI-X | Chromic

The Tri-x chromic lens are made to suit every weather condition. The lens changes its shading automatically and instantly from light to dark and back again based on the weather condition.

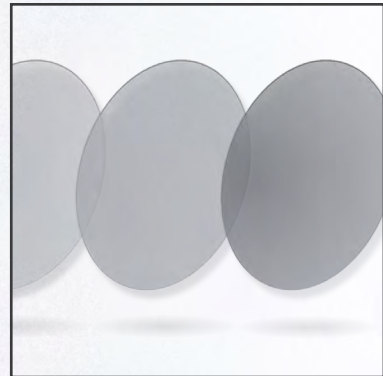

TRI-X | Polarized

The Tri-x polarized lens cuts out all reflecting light rays. No more glare from water, snow, wet roads or other reflecting materials.

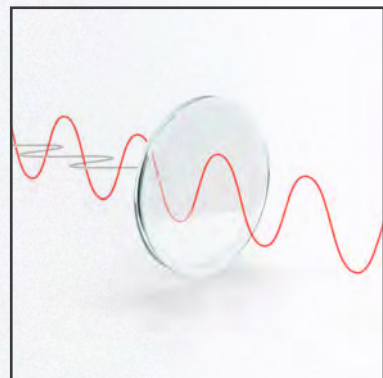

TRI-X | Polarized

At sea	● ● ● ● ●	5
On the road	● ● ● ● ●	5
Fishing	● ● ● ● ●	5
Glacier	● ● ● ● ●	5

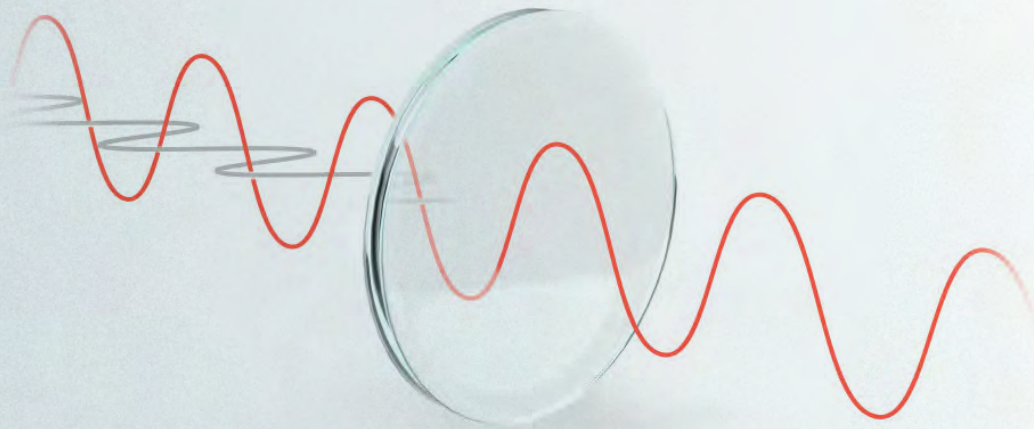

| Polarized

Tired of being blinded by harsh glare when you're out and about? It's time to see the world in all its glory without the annoying distractions. Say hello to the Tri-x Polarized Lens – the ultimate solution to eliminate reflections and enhance your visual experience!

Glare-Free Clarity:

Tri-x Polarized lenses are meticulously crafted to cut out all those pesky reflecting light rays. Whether it's blinding sunbeams on water, glistening snow, or slick, wet roads, our lenses ensure you see clearly without any distracting glare.

Uninterrupted Water Adventures:

Love spending time by the water but hate the glare bouncing off the surface? Tri-x Polarized is your perfect companion for fishing, boating, or simply soaking up the sun by the beach. Dive into crystal-clear vision, and don't let glare spoil your aquatic fun!

Safely Navigate Snowy Slopes:

Skiing or snowboarding on bright, sunny days?

Tri-x Polarized keeps your vision sharp without those blinding reflections on the slopes. Enjoy your winter adventures without squinting in the snow.

Safer Road Trips:

Road trips are a breeze with Tri-x Polarized. Say goodbye to the blinding headlights of oncoming cars and the shimmering glare on wet roads. Drive safely and comfortably, day or night.

True Colors Shine Through:

Our lenses not only eliminate glare but also reveal the true beauty of your surroundings. Experience vibrant colors, enhanced contrast, and a world filled with stunning detail.

Rediscover the world in all its glory with Tri-x Polarized. Don't let annoying reflections hinder your experiences – choose the lens that lets you see the world on your terms. Tri-x Polarized – where clarity meets style, and glare becomes a thing of the past!

001 Treriksröset Tri-x Polarized



TS0003S009
Frame: Shiny transparent black
Lens: Polarized brown/silver mirror. Cat 3

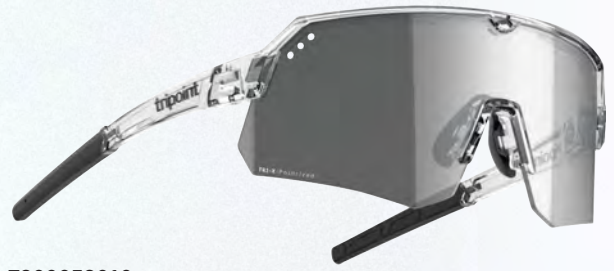

TS0003S010
Frame: Shiny crystal
Lens: Polarized brown/silver mirror. Cat 3

003 Reschen Tri-x Polarized



TS0006S010
Frame: Shiny transparent black
Lens: Polarized brown/silver mirror. Cat 3



TS0006S011
Frame: Shiny crystal
Lens: Polarized brown/silver mirror. Cat 3

007 Chobe Tri-x Polarized



TS0007S001
Frame: Shiny transparent black
Lens: Polarized brown/silver mirror. Cat 3

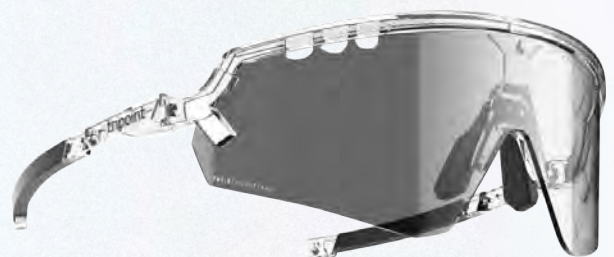

TS0007S002
Frame: Shiny crystal
Lens: Polarized brown/silver mirror. Cat 3

TRI-X | Chromic

Indoor & night	● ● ● ● ●	5
Cloudy days	● ● ● ● ●	5
Bright & sunny days	● ● ● ● ●	5

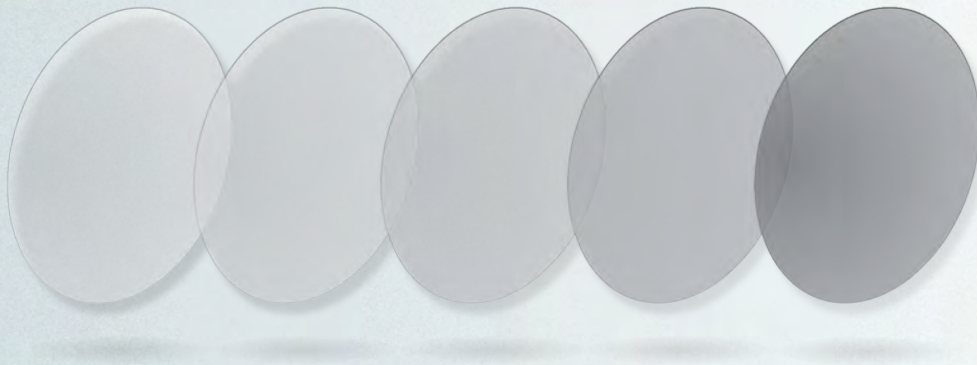

| Chromic

Are you tired of constantly switching between different lenses to match ever-changing weather conditions? Say hello to the future of eyewear with Tri-x Chromic – the lens that adapts instantly to your surroundings!

Seamless Adaptation:

Tri-x Chromic lenses are the perfect solution for unpredictable weather. They effortlessly transition from light to dark and back again, ensuring optimal visibility in any condition. No more squinting in bright sunlight or straining your eyes on cloudy days.

All-Weather Performance:

Whether you're hitting the slopes on a sunny day or braving a sudden rainstorm, Tri-x Chromic has you covered. Say goodbye to the hassle of swapping lenses – enjoy your outdoor activities without interruption.

Uncompromised Clarity:

Our advanced technology doesn't just adapt to changing light; it enhances your vision. With

Tri-x Chromic, you'll experience vivid colors and sharp details, no matter what Mother Nature throws your way.

Stylish and Functional:

Tri-x Chromic lenses aren't just about performance; they're a style statement too. These sleek, modern lenses complement any frame, allowing you to look great while seeing clearly.

Instant Transition:

The magic of Tri-x Chromic happens in the blink of an eye. Experience a lens that responds instantly to light conditions, providing you with the perfect shade when you need it most.

Be prepared for every moment with Tri-x Chromic and enjoy a seamless, adaptable visual experience like never before. Don't let changing weather dampen your day – embrace the future of eyewear with Tri-x Chromic! Your vision, your style, your comfort – all in one remarkable lens.

001 Treriksröset Tri-x Chromic



TS0003S007
Frame: Shiny transparent black
Lens: Photochromic smoke/blue multi. Cat 0-3



TS0003S008
Frame: Shiny crystal
Lens: Photochromic smoke/blue multi. Cat 0-3

003 Reschen Tri-x Chromic



TS0006S008
Frame: Shiny transparent black
Lens: Photochromic smoke/blue multi. Cat 0-3



TS0006S009
Frame: Shiny crystal
Lens: Photochromic smoke/blue multi. Cat 0-3

007 Chobe Tri-x Chromic



TS0007S003
Frame: Shiny transparent black
Lens: Photochromic smoke/blue multi. Cat 0-3



TS0007S004
Frame: Shiny crystal
Lens: Photochromic smoke/blue multi. Cat 0-3

TRI-X | UltraVue

Contrast enhancer ● ● ● ● ● 5

Low light conditions ● ● ● ● ● 5

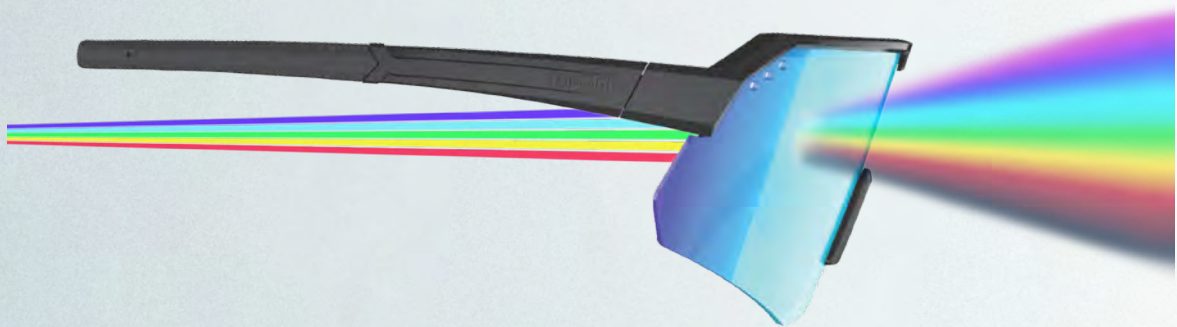

| UltraVue

Are you tired of dull, fuzzy visuals in low-light conditions while enjoying your favorite activities? Say goodbye to those frustrating moments, because Tri-x UltraVue is here to revolutionize your experience!

Enhanced Color and Contrast:

Tri-x UltraVue lenses are expertly designed to intensify colors and contrast in low-light settings. No more struggling to distinguish details or battling the blur of fuzzy colors – our lenses cut through the haze for a vibrant, crisp view!

Optimal Clarity in Low Light:

Whether you're hitting the slopes at dusk, venturing out for an evening hike, or simply navigating dimly lit environments, Tri-x UltraVue ensures you see with precision. Our advanced technology lets you enjoy every moment with unparalleled clarity.

Versatile Performance:

Tri-x UltraVue lenses aren't just for one activity; they're your all-in-one solution for any low-light situation. From skiing and snowboarding to nighttime strolls and indoor events, you can trust Tri-x to enhance your vision every time.

See the World in True Colors:

Experience the world as it's meant to be seen – vibrant, sharp, and full of detail. Tri-x UltraVue lenses block out the noise of fuzzy colors, revealing the true beauty around you, even when the sun has set.

Become one with your vision and seize every moment, no matter the lighting conditions. Discover the Tri-x UltraVue difference today and elevate your visual experience to new heights! Don't settle for less when you can have the best.

001 Treriksroset

Tri-x UltraVue



TS0003S001
Frame: Shiny transparent black
Lens: Orange/blue multi. Cat 1



TS0003S003
Frame: Shiny transparent black
Lens: Violet/blue multi. Cat 2



TS0003S002
Frame: Shiny crystal
Lens: Orange/blue multi. Cat 1



TS0003S004
Frame: Shiny crystal
Lens: Violet/blue multi. Cat 2

003 Reschen

Tri-x UltraVue



TS0006S001
Frame: Shiny transparent black
Lens: Orange/blue multi. Cat 1



TS0006S003
Frame: Shiny transparent black
Lens: Violet/blue multi. Cat 2



TS0006S002
Frame: Shiny crystal
Lens: Orange/blue multi. Cat 1



TS0006S004
Frame: Shiny crystal
Lens: Violet/blue multi. Cat 2

007 Chobe

Tri-x UltraVue



TS0007S005
Frame: Shiny transparent black
Lens: Orange/blue multi. Cat 1



TS0007S007
Frame: Shiny transparent black
Lens: Violet/blue multi. Cat 2



TS0007S006
Frame: Shiny crystal
Lens: Orange/blue multi. Cat 1



TS0007S008
Frame: Shiny crystal
Lens: Violet/blue multi. Cat 2

WHY TRIPPOINT SPORTS GLASSES?



PROTECT YOUR EYES

Your glasses should not only protect your eyes from dangerous UVA and UVB rays, but they should also protect your eyes against wind, dust, bugs, rain, snow, sleet and anything else that you may encounter. It is therefore important that your sports glasses have both great fit and complete eye coverage. Tripoint is developed with carefully selected materials that are gentle and comfortable against the skin.

STAY IN PLACE COMFORTABLY

Your sport glasses should NOT move around during your activities. If they do, they could cause irritation on the skin, obstruct vision and worst of all, become a distraction from your sport rather than an aid to your sport. Tripoint come with a Tri-Click Nose System for extremely easy adjustment, together with infinitely adjustable rubber temples. This means that Tripoint sports glasses can stay comfortably in the right place with no slippage, to only enhance your performance.



BI**♻️**BASED NYLON



UNOBSTRUCTED VISION WITH BIOBASED NYLON LENSES

For maximal safety and top performance it is important that your glasses do not obstruct your vision and only enhance it. Tripoint comes with a biobased Nylon lens with extremely high optical quality. The Nylon lens is both lighter and provides a clearer view than Polycarbonate, which is the most common material for lenses in sports glasses. The lens is also flexible, resistant and has a good "memory". If you bump or bend them, they will return to their original shape. Nylon as a material is also free from BPA, which is a chemically harmful substance for the body. Not only does the lens provide better performance, but it also has less impact on the environment in the manufacturing process. Tripoint also offers an endless amount of interchangeable lenses to maximize vision in the widest variety of different weather conditions. Tripoint complies with standards EN ISO 12312-1, AS/NZS 1067 & ANSI Z80.3.

LIGHT WEIGHT BIOBASED NYLON FRAME

The biobased frame is made of a strong lightweight Nylon material and puts minimal strain on the nose, ears and environment thanks to the low weight and biobased material. To ensure maximum mobility for the head and minimum tension in the neck, Tripoint sports glasses are superlight, they often weight less than 40g.

69°03'35"N 20°32'49"E

001 Treriksörset

Tech & Soul

BIO-BASED TRI-X | Nylon

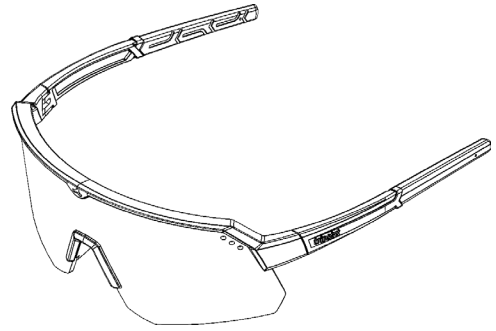

Description

TRI-X | Nylon

30 years of experience in the sport and fashion eyewear industry has led us to this style - 001 Treriksörset. Treriksörset is the ideal model for speed sports such as mountain biking, road biking or skiing. But still just as stylish to be able to fit on a catwalk. A sober and pure design, combining style and technicality: Its wrap-around lens offers optimal protection against the wind generated by speed, but also against branches that you may encounter on your way.

Enjoy increased peripheral vision and clarity with the biobased Nylon lens, an essential factor in improving your visual accuracy and therefore, your sporting performance! Its 100% UV protective lens will counteract tired eyes for many years to come.

A durable model designed to last: 001 Treriksörset is made of 45% organic polyamide sourced from castor oil, carefully selected for its lightness, flexibility and resistance to shocks.

Keep your 001 Treriksörset in top condition: the storage pouch is specially designed to keep your shades safe. And the cleaning wipe keeps the dirt away, for permanent visual comfort.

Standards

This model meets the standards EN ISO 12312-1, AS/NZS 1067 & ANSI Z80.3 for sunglasses.

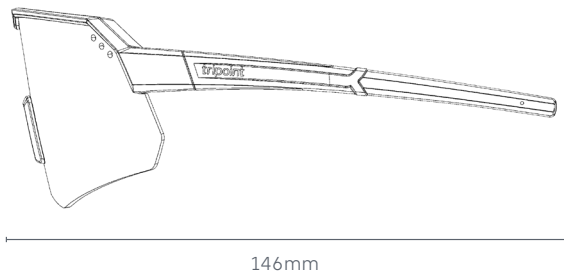

146mm

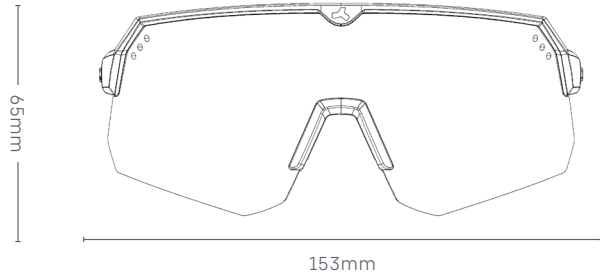

65mm

153mm

Technical Features

Tri-click nose System

The unique system makes the nose part easy to adjust and maintains the shape that the user himself specified. The nose part is rubber-coated and provides the user with comfort during longer and tougher forms of activity.

Tri-bend temple tips

The rubberized temple tips are adaptable and easy to adjust to your head for a stable and comfortable use for extended periods.

Tri-field wrap-around

The wrap-around frame provides a wide field of vision and enhanced peripheral eyesight to ensure optimal visual accuracy and improve your sports performance.

Biobased Nylon frame

The frame is made of 45% organic sourced polyamide with castor oil. The nylon material is both strong and light weighted. The Frame puts minimal strain on the nose, ears and environment at the same time.

Biobased Nylon lens

The Biobased Nylon lens is both lighter and provides a clearer view than Polycarbonate, which is the most common material for lenses in sports glasses. The lens is flexible, resistant and has a good "memory". If you bump or bend them, they will return to their original shape. Nylon as a material is also free from BPA which is a chemically harmful substance for the body.

Hydrophobic/Oleophobic

Our top of the line Hydrophobic + Oleophobic treatment ensures water, oil and dirt pearl off your lenses.

Tri-dot ventilation

The right amount of air ventilation can be important to keep the fog away. Our tri-dots provide the user with enough air circulation for a fog-free experience.

100% UV400 Protection

Our lenses block all harmful UVA, UVB & UVC light rays with wavelengths up to 400 nanometers – regardless of sun or cloud conditions.

Interchangeable lens

The weather conditions can suddenly change, then it might be handy to have a spare lens ready. On this frame, you can easily change from one lens to a lens that is best suited for the moment. Spare lenses are available for purchase.

Optical insert (available as an accessory)

RX-able optical insert which can be taken to an optician and fitted with your own prescription lenses.

Click hinge

High quality click hinge for a long-lasting temple. Free from squeaking sound, loose screws and unexpected folding.

Overview

001 Treriksroset

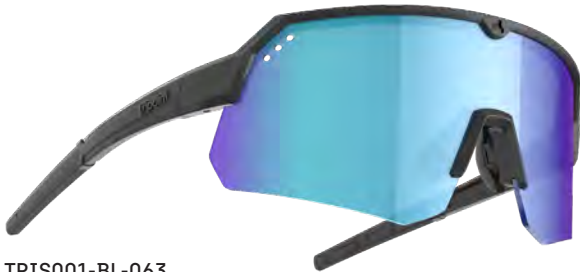

TRIS001-BL-063
 Frame: Matt black
 Lens: smoke/blue multi. Cat 3



TRIS001-BR-103G
 Frame: Transparent brown
 Lens: Gradient brown. Cat 2



TRIS001-BL-003
 Frame: Matt black
 Lens: Smoke. Cat 3



TRIS001-BE-073
 Frame: Turquoise
 Lens: Smoke/pink multi. Cat 3



TRIS001-GN-793
 Frame: Matt dark petrol
 Lens: Pink/silver mirror. Cat 3



TRIS001-PN-693
 Frame: Matt pink
 Lens: Blue/silver mirror. Cat 3

Spare parts

Spare lens
 TRISL001-8: Clear. Cat 0



Spare lens
 TRISL001-7: Pink. Cat 1



Optical adapter →
 Clear. Cat 0



- Black: TRIS001-OA-BL
- White: TRIS001-OA-WH
- Transparent brown: TRIS001-OA-BR
- Petrol: TRIS001-OA-BE
- Powder pink: TRIS001-OA-PI
- Burgundy: TRIS001-OA-RD
- Transparent yellow: TRIS001-OA-YL
- Transparent turquoise: TRIS001-OA-TQ

27°53'N 88°8'E

002 Jongsong Peak

Free & Strong

BIO-
BASED TRI-X | Nylon

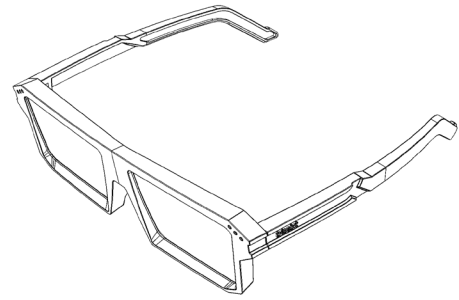

Description

Innovative hybrid frame that flirts with the eyewear fashion industry. 002 Jongsong Peak is a versatile model that works best when your everyday life flows into one. You want to train, work, study, travel, have coffee and go to a party. But can't you have only one pair of glasses for all of that? Well... Jongsong Peak allows you to mix function, technology and fashion awareness. All at the same time.

Enjoy crisp and clear vision with the biobased Nylon lens, an essential factor in improving your visual accuracy and therefore, your sporting performance! Its 100% UV protective lens will counteract tired eyes for many years to come.

A durable model designed to last: 002 Jongsong Peak is made of 45% organic polyamide sourced from castor oil, carefully selected for its lightness, flexibility and resistance to shocks.

Keep your 002 Jongsong Peak in top condition: the storage pouch is specially designed to keep your shades safe. And the cleaning wipe keeps the dirt away, for permanent visual comfort.

Standards

This model meets the standards EN ISO 12312-1, AS/NZS 1067 & ANSI Z80.3 for sunglasses.

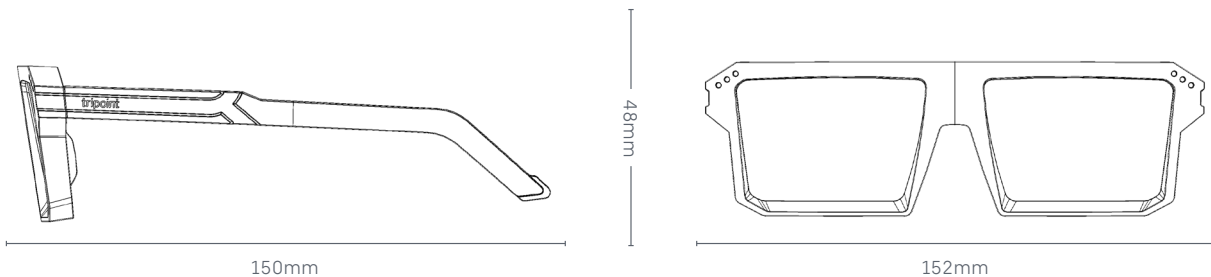

Technical Features

Comfy rubber temple tips

The rubberized temple tips are adaptable and easy to adjust to your head for a stable and comfortable use for extended periods.

Biobased Nylon frame

The frame is made of 45% organic sourced polyamide with castor oil. The nylon material is both strong and light weighted. The Frame puts minimal strain on the nose, ears and environment at the same time.

Biobased Nylon lens

The Biobased Nylon lens is both lighter and provides a clearer view than Polycarbonate, which is the most common material for lenses in sports glasses. The lens is flexible, resistant and has a good "memory". If you bump or bend them, they will return to their original shape. Nylon as a material is also free from BPA which is a chemically harmful substance for the body.

Hydrophobic/Oleophobic

Our top of the line Hydrophobic + Oleophobic treatment ensures water, oil and dirt pearl off your lenses.

100% UV400 Protection

Our lenses block all harmful UVA, UVB & UVC light rays with wavelengths up to 400 nanometers – regardless of sun or cloud conditions.

Click hinge

High quality click hinge for a long-lasting temple. Free from squeaking sound, loose screws and unexpected folding.

Overview

002 Jongsong Peak



TRIS002-BL-003
Frame: Matt black
Lens: Smoke. Cat 3



TRIS002-BL-503G
Frame: Matt black
Lens: Gradient green. Cat 1

46°50'53"N 10°30'18"E

003 Reschen

Life & Globe

BIO-
BASED TRI-X | Nylon

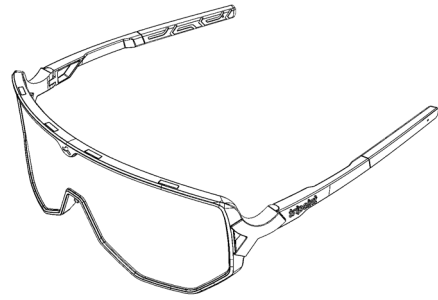

Description

TRI-X | Nylon

003 Reschen is the perfect companion for a life in motion. The world has so much to offer, people, nature, activities, culture. You want to absorb everything, you are curious. Around the next bend, new adventures, new surprises await. Unpredictability is what makes you feel good, unpredictability is what these glasses are made for.

Enjoy increased peripheral vision and clarity with the biobased Nylon lens, an essential factor in improving your visual accuracy and therefore, your sporting performance! Its 100% UV protective lens will counteract tired eyes for many years to come.

A durable model designed to last: 003 Reschen is made of 45% organic polyamide sourced from castor oil, carefully selected for its lightness, flexibility and resistance to shocks.

Keep your 003 Reschen in top condition: the storage pouch is specially designed to keep your shades safe. And the cleaning wipe keeps the dirt away, for permanent visual comfort.

Standards

This model meets the standards EN ISO 12312-1, AS/NZS 1067 & ANSI Z80.3 for sunglasses.

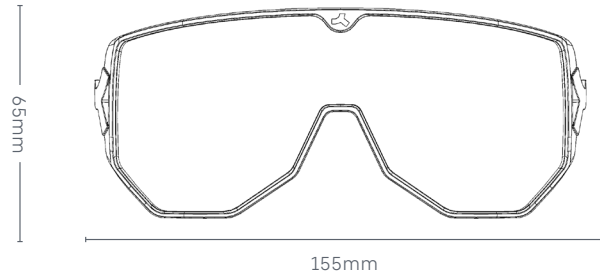
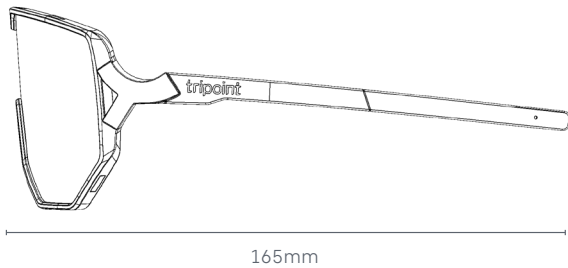

Technical Features

Tri-click nose system

The unique system makes the nose part easy to adjust and maintains the shape that the user himself specified. The nose part is rubber-coated and provides the user with comfort during longer and tougher forms of activity.

Tri-bend temple tips

The rubberized temple tips are adaptable and easy to adjust to your head for a stable and comfortable use for extended periods.

Tri-field full frame

The full-frame provides a wide field of vision and enhanced peripheral eyesight to ensure optimal visual accuracy and improve your sports performance.

Biobased Nylon frame

The frame is made of 45% organic sourced polyamide with castor oil. The nylon material is both strong and light weighted. The Frame puts minimal strain on the nose, ears and environment at the same time.

Biobased Nylon lens

The Biobased Nylon lens is both lighter and provides a clearer view than Polycarbonate, which is the most common material for lenses in sports glasses. The lens is flexible, resistant and has a good "memory". If you bump or bend them, they will return to their original shape. Nylon as a material is also free from BPA which is a chemically harmful substance for the body.

Hydrophobic/Oleophobic

Our top of the line Hydrophobic + Oleophobic treatment ensures water, oil and dirt pearl off your lenses.

100% UV400 Protection

Our lenses block all harmful UVA, UVB & UVC light rays with wavelengths up to 400 nanometers – regardless of sun or cloud conditions.

Interchangeable lens

The weather conditions can suddenly change, then it might be handy to have a spare lens ready. On this frame, you can easily change from one lens to a lens that is best suited for the moment. Spare lenses are available for purchase.

Click hinge

High quality click hinge for a long-lasting temple. Free from squeaking sound, loose screws and unexpected folding.

Overview

003 Reschen



TRIS003-BL-003
Frame: Matt black
Lens: Smoke. Cat 3



TRIS003-BL-063
Frame: Matt black
Lens: Smoke/blue multi. Cat 3



TRIS003-BR-103G
Frame: Transparent brown
Lens: Gradient brown. Cat 2

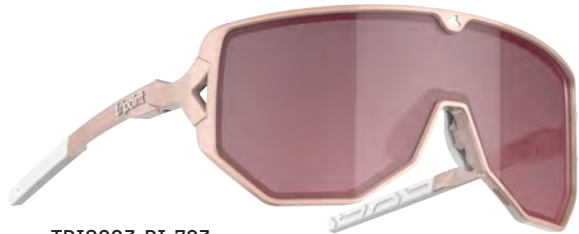

TRIS003-PI-793
Frame: Shiny milky pink
Lens: Pink/silver mirror. Cat 3



TRIS003-WH-203
Frame: White
Lens: Purple. Cat 2

Spare parts

Spare lens
TRISL003-8: Clear. Cat 0



Spare lens
TRISL003-7: Pink. Cat 1



48°00'24"N 17°09'38"E

004 Rajka

Life & Globe

BIO-BASED

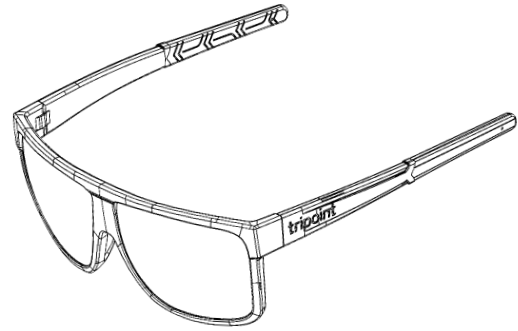

Description

004 Rajka is your go to glasses when you're on the run and don't know how the day will end up. 004 Rajka is made to fit almost any situation.

The lens in Polycarbonate has high impact resistance and a good optical quality for clear and crisp vision. Its 100% UV protective lens will block all harmful light rays, no matter weather condition.

Keep your 004 Rajka in top condition: the storage pouch is specially designed to keep your shades safe. And the cleaning wipe keeps the dirt away, for permanent visual comfort.

Standards

This model meets the standards EN ISO 12312-1, AS/NZS 1067 & ANSI Z80.3 for sunglasses.

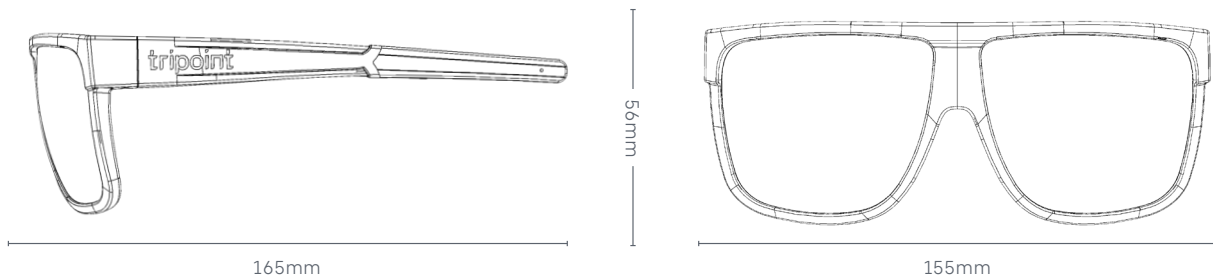

Technical Features

Tri-Bend Temple Tips

The rubberized temple tips are adaptable and easy to adjust to your head for a stable and comfortable use for extended periods.

Tri-Field Full Frame

The full-frame provides a wide field of vision and enhanced peripheral vision to ensure optimal reflexes and improve your sports performance.

Biobased Nylon frame

The frame is made of 45% organic sourced polyamide with castor oil. The nylon material are both strong and light weighted. The Frame puts minimal strain on the nose, ears and environment at the same time.

Polycarbonate lens

The lens in Polycarbonate has high impact resistance and a good optical quality for clear and crisp vision.

Hydrophobic/Oleophobic

Our top of the line Hydrophobic + Oleophobic treatment ensures water, oil and dirt pearl off your lenses.

100% UV400 Protection

Our lenses block all harmful UVA, UVB & UVC light rays with wavelengths up to 400 nanometers – regardless of sun or cloud conditions.

Click hinge

High quality click hinge for a long-lasting temple. Free from squeaking sound, loose screws and unexpected folding.

Overview

004 Rajka



TRIS004-BL-003
Frame: Matt black
Lens: Smoke. Cat 3



TRIS004-BR-103G
Frame: Transparent brown
Lens: Gradient brown. Cat 3

1°0'S 33°55'E

005 Lake Victoria

Tech & Soul

BIO-BASED

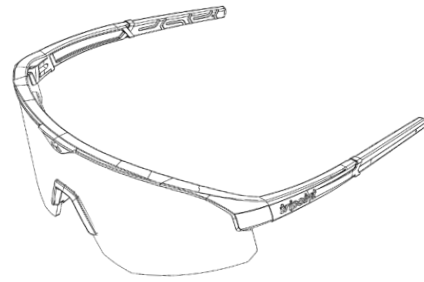

Description

Elevate your performance and style with the 005 Lake Victoria sports glasses.

Experience the pinnacle of sports eyewear innovation with the 005 Lake Victoria model. Crafted to excel in speed sports like mountain biking, road biking, and skiing, it seamlessly merges function and fashion. environment.

Its refined design effortlessly marries form and function. The wrap-around lens provides unparalleled protection against wind and obstacles, offering a blend of elegance and performance.

The wide polycarbonate lens provide peripheral vision, clarity and high impact resistance. Equipped with a 100% UV protective lens, Lake Victoria

safeguards against tired eyes and the effects of harmful rays.

005 Lake Victoria is designed to withstand the test of time, the frame is made from 45% organic polyamide sourced from castor oil. This ensures lightweight flexibility, while its shock resistance guarantees longevity.

Keep your 005 Lake Victoria sports glasses in mint condition with the tailored storage pouch. The included cleaning wipe ensures lasting visual comfort by keeping dirt at bay.

Standards

This model meets the standards EN ISO 12312-1, AS/NZS 1067 & ANSI Z80.3 for sunglasses.

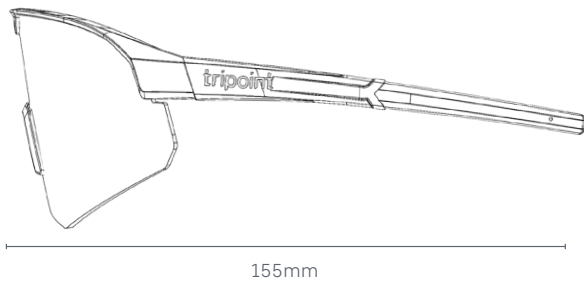

65mm

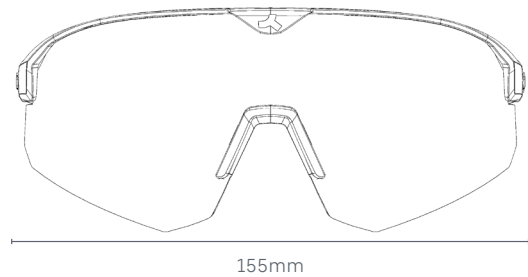

155mm

Technical Features

Tri-click nose System

The unique system makes the nose part easy to adjust and maintains the shape that the user himself specified. The nose part is rubber-coated and provides the user with comfort during longer and tougher forms of activity.

Tri-Bend Temple Tips

The rubberized temple tips are adaptable and easy to adjust to your head for a stable and comfortable use for extended periods.

Tri-field wrap-around

The wrap-around frame provides a wide field of vision and enhanced peripheral eyesight to ensure optimal visual accuracy and improve your sports performance.

Biobased Nylon frame

The frame is made of 45% organic sourced polyamide with castor oil. The nylon material are both strong and light weighted. The Frame puts minimal strain on the nose, ears and environment at the same time.

Polycarbonate lens

The lens in Polycarbonate has high impact resistance and a good optical quality for clear and crisp vision.

Interchangeable lens

The weather conditions can suddenly change, then it might be handy to have a spare lens ready. On this frame, you can easily change from one lens to a lens that is best suited for the moment. Spare lenses are available for purchase.

Hydrophobic/Oleophobic

Our top of the line Hydrophobic + Oleophobic treatment ensures water, oil and dirt peel off your lenses.

100% UV400 Protection

Our lenses block all harmful UVA, UVB & UVC light rays with wavelengths up to 400 nanometers – regardless of sun or cloud conditions.

Click hinge

High quality click hinge for a long-lasting temple. Free from squeaking sound, loose screws and unexpected folding.

Overview

005 Lake Victoria



TRIS005-BL-183
 Frame: Matt black
 Lens: Brown/ice blue multi. Cat 3



TRIS005-WH-063
 Frame: Matt black
 Lens: Smoke/ice blue multi. Cat 3



TRIS005-PN-173
 Frame: Matt light pink
 Lens: Brown/pink multi. Cat 3



TRIS005-YL-123
 Frame: Transparent neon yellow
 Lens: Smoke. Cat 3



TRIS005-RD-173
 Frame: Matt burgundy
 Lens: Brown/pink multi. Cat 3



TRIS005-BL-173
 Frame: Transparent neon turquoise
 Lens: Brown/pink multi. Cat 3

Spare parts

Spare lens
 TRISL005-8: Clear. Cat 0



Spare lens
 TRISL005-7: Pink. Cat 1



Optical adapter →
 Clear. Cat 0



- Black:** TRIS001-OA-BL
- White:** TRIS001-OA-WH
- Transparent brown:** TRIS001-OA-BR
- Petrol:** TRIS001-OA-BE
- Powder pink:** TRIS001-OA-PI
- Burgundy:** TRIS001-OA-RD
- Transparent yellow:** TRIS001-OA-YL
- Transparent turquoise:** TRIS001-OA-TQ

006 1°0'S 33°55'E Lake Victoria Small

Tech & Soul

BIO-
BASED

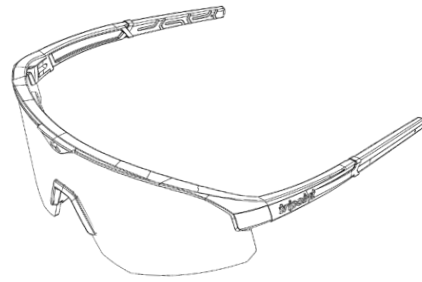

Description

Elevate your performance and style with the 006 Lake Victoria small sports glasses.

Experience the pinnacle of sports eyewear innovation with the 006 Lake Victoria small model. Crafted to excel in speed sports like mountain biking, road biking, and skiing, it seamlessly merges function and fashion. environment.

Its refined design effortlessly marries form and function. The wrap-around lens provides unparalleled protection against wind and obstacles, offering a blend of elegance and performance.

The wide polycarbonate lens provide peripheral vision, clarity and high impact resistance. Equipped with a 100% UV protective lens, Lake Victoria

safeguards against tired eyes and the effects of harmful rays.

006 Lake Victoria is designed to withstand the test of time, the frame is made from 45% organic polyamide sourced from castor oil. This ensures lightweight flexibility, while its shock resistance guarantees longevity.

Keep your 006 Lake Victoria small sports glasses in mint condition with the tailored storage pouch. The included cleaning wipe ensures lasting visual comfort by keeping dirt at bay.

Standards

This model meets the standards EN ISO 12312-1, AS/NZS 1067 & ANSI Z80.3 for sunglasses.

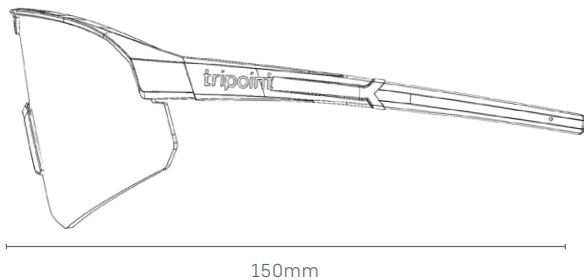

60mm

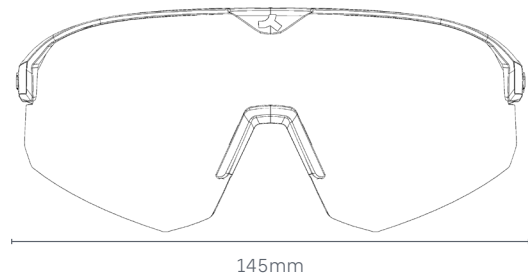

145mm

Technical Features

Tri-click nose System

The unique system makes the nose part easy to adjust and maintains the shape that the user himself specified. The nose part is rubber-coated and provides the user with comfort during longer and tougher forms of activity.

Tri-Bend Temple Tips

The rubberized temple tips are adaptable and easy to adjust to your head for a stable and comfortable use for extended periods.

Tri-field wrap-around

The wrap-around frame provides a wide field of vision and enhanced peripheral eyesight to ensure optimal visual accuracy and improve your sports performance.

Biobased Nylon frame

The frame is made of 45% organic sourced polyamide with castor oil. The nylon material are both strong and light weighted. The Frame puts minimal strain on the nose, ears and environment at the same time.

Polycarbonate lens

The lens in Polycarbonate has high impact resistance and a good optical quality for clear and crisp vision.

Interchangeable lens

The weather conditions can suddenly change, then it might be handy to have a spare lens ready. On this frame, you can easily change from one lens to a lens that is best suited for the moment. Spare lenses are available for purchase.

Hydrophobic/Oleophobic

Our top of the line Hydrophobic + Oleophobic treatment ensures water, oil and dirt peel off your lenses.

100% UV400 Protection

Our lenses block all harmful UVA, UVB & UVC light rays with wavelengths up to 400 nanometers – regardless of sun or cloud conditions.

Click hinge

High quality click hinge for a long-lasting temple. Free from squeaking sound, loose screws and unexpected folding.

Overview

006 Lake Victoria small



TRIS006-BL-183
 Frame: Matt black
 Lens: Brown/ice blue multi. Cat 3



TRIS006-WH-063
 Frame: Matt black
 Lens: Smoke/ice blue multi. Cat 3



TRIS006-PN-173
 Frame: Matt light pink
 Lens: Brown/pink multi. Cat 3



TRIS006-YL-123
 Frame: Transparent neon yellow
 Lens: Smoke. Cat 3



TRIS006-RD-173
 Frame: Matt burgundy
 Lens: Brown/pink multi. Cat 3



TRIS006-BL-173
 Frame: Transparent neon turquoise
 Lens: Brown/pink multi. Cat 3

Spare parts

Spare lens
 TRISL006-8: Clear. Cat 0



Spare lens
 TRISL006-7: Pink. Cat 1



Optical adapter →
 Clear. Cat 0



- Black: TRIS001-OA-BL
- White: TRIS001-OA-WH
- Transparent brown: TRIS001-OA-BR
- Petrol: TRIS001-OA-BE
- Powder pink: TRIS001-OA-PI
- Burgundy: TRIS001-OA-RD
- Transparent yellow: TRIS001-OA-YL
- Transparent turquoise: TRIS001-OA-TQ

007 17°47'16"S 25°15'24"E Chobe

Tech & Soul

BIO-BASED

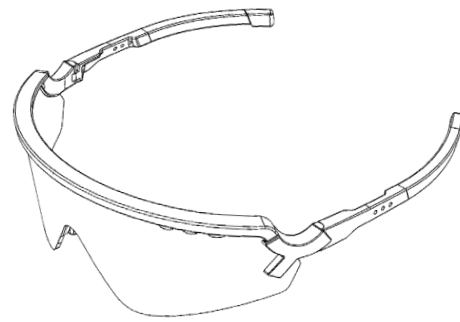

Description

Elevate your performance and step up your style game with the remarkable 007 Chobe sports glasses. These versatile frames are carefully engineered to cater to your every multisport need. The high basecurve design ensures a snug fit against your face, making them the perfect choice for both gusty winds and radiant sunshine.

Crafted to excel in high-speed sports such as mountain biking, road biking, surfing and skiing, it effortlessly blends fashion with function.

Its sleek design seamlessly marries aesthetics and practicality. The wrap-around lens offers unmatched protection against wind and obstacles, marrying elegance with top-tier performance. It's like having a second skin glued to your face.

The wide polycarbonate lens delivers exceptional peripheral vision, crystal-clear clarity, and remarkable high-im-

pact resistance. Equipped with a 100% UV protective lens, the 007 Chobe safeguards your eyes against fatigue and the harmful effects of UV rays.

Designed for longevity, the 007 Chobe frame is constructed from 45% organic polyamide sourced from castor oil. This ensures lightweight flexibility, while its shock resistance guarantees lasting durability.

To keep your 007 Chobe sports glasses in pristine condition, we provide a tailored storage pouch and a cleaning wipe. This ensures enduring visual comfort by keeping dirt and smudges at bay.

Standards

This model meets the standards EN ISO 12312-1, AS/NZS 1067 & ANSI Z80.3 for sunglasses.

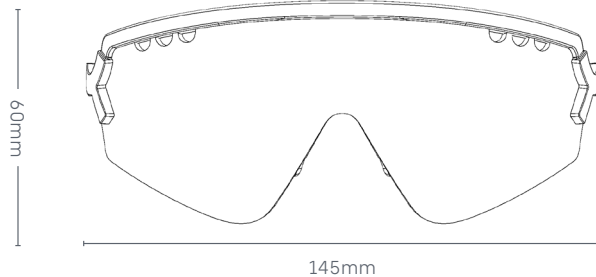
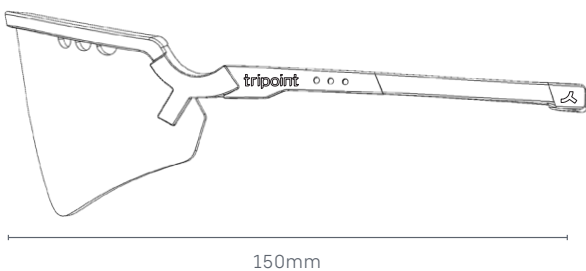

Technical Features

Tri-flex Nose System

This unique system allows for easy adjustment of the nose piece at any angle specified by the user. The nose piece is rubber-coated, providing comfort during extended and more strenuous activities.

Tri-Bend Temple Tips

The rubberized temple tips are adaptable and easy to adjust to your head for a stable and comfortable use for extended periods.

Tri-field wrap-around

The wrap-around frame provides a wide field of vision and enhanced peripheral eyesight to ensure optimal visual accuracy and improve your sports performance.

Biobased Nylon frame

The frame is made of 45% organic sourced polyamide with castor oil. The nylon material are both strong and light weighted. The Frame puts minimal strain on the nose, ears and environment at the same time.

Polycarbonate lens

The lens in Polycarbonate has high impact resistance and a good optical quality for clear and crisp vision.

Interchangeable lens

The weather conditions can suddenly change, then it might be handy to have a spare lens ready. On this frame, you can easily change from one lens to a lens that is best suited for the moment. Spare lenses are available for purchase.

Hydrophobic/Oleophobic

Our top of the line Hydrophobic + Oleophobic treatment ensures water, oil and dirt pearl off your lenses.

100% UV400 Protection

Our lenses block all harmful UVA, UVB & UVC light rays with wavelengths up to 400 nanometers – regardless of sun or cloud conditions.

Click hinge

High quality click hinge for a long-lasting temple. Free from squeaking sound, loose screws and unexpected folding.

Floating Neck Cord

Included with your sports glasses is an attachable neck cord for added convenience. This neck cord boasts a unique floating feature, ensuring that should you accidentally drop your glasses in the water, they'll stay afloat and easily retrievable.

Moreover, it's a handy accessory if you prefer to keep your glasses hanging around your neck when they're not in use. With this floating neck cord, you get both practical functionality and peace of mind, making it a valuable addition to your sports eyewear.

Overview

007 Chobe



TS0007S011
Frame: Matt light purple
Lens: Purple/purple multi. Cat 3

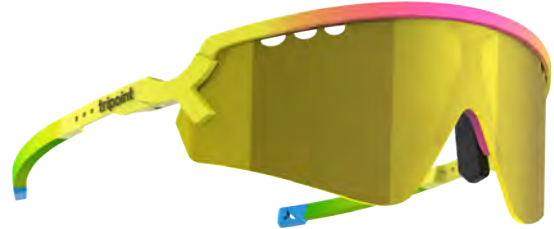

TS0007S012
Frame: Multi color
Lens: Brown/yellow multi. Cat 3



TS0007S013
Frame: Matt black
Lens: Brown/bronze multi. Cat 3



TS0007S014
Frame: Matt yellow
Lens: Brown/purple multi. Cat 3

Merch



Tripoint mango drink

Tee



Bag



Hat



Displays



Wood display desk



Wood display floor



Wood display floor event combi

Sports glasses floor combi display



Goggles



Helmets



